



Japan Credit Rating Agency, Ltd. (JCR) will announce the following Green Finance Framework Evaluation Results.

Sumitomo Metal Mining Co., Ltd.

Green Finance Framework

Assignment



Issuer/Borrower	Sumitomo Metal Mining Co., Ltd. (security code: 5713)
Evaluation Target	Green Finance Framework

Evaluation Overview

▶▶▶ 1. Overview of Sumitomo Metal Mining Co., Ltd.

Sumitomo Metal Mining Co., Ltd. (hereinafter referred to as "SMM" or "the Company") is a global firm whose strength is to secure its competitive advantages through the cooperation of 3-businesses: Mineral Resources; Smelting & Refining; and Material. The main non-ferrous metals handled are nickel, copper and gold. Copper has excellent mining interests around the world, and gold has the Hishikari Mine, which is the only large-scale commercial production in Japan. The Company has also actively made investments to acquire new resources. Holding domestic and overseas smelters and refineries with high resource efficiency/cost competitiveness has also expanded SMM's business opportunities. The Material Business in collaboration with Smelting & Refining Business who has optimized and stably provided raw materials has secured final products of high quality.

The Sumitomo Metal Mining Group (hereinafter referred to as "the SMM Group" or "the Group") has aimed to become the world leader in the non-ferrous metals industry as its long-term vision. Its business model is characterized by the 3-business collaboration between non-ferrous metal operating companies that are globally unique. The 3-business refers to: (1) Mineral Resources Business who has developed and operated mines in a way that is considerate to the environment and society; (2) Smelting & Refining Business who has generated high-quality metal materials from the extracted ores; and (3) Materials Business who has added new value to these materials that meet the needs of the times. The SMM Group's 3-business collaboration that covers from resource development to smelting & refining and production of functional materials in a consistent fashion, has also utilized for the production of cathode materials for automotive secondary batteries and recycling of lithium-ion secondary batteries for which the proceeds will be used in this Framework, which are major axes in order for the SMM Group to improve its long-term corporate value and simultaneously important initiatives to maintain its competitive advantages.

▶▶▶ 2. SMM' ESG Management and Decarbonization Initiatives

The SMM Group has set forth a long-term vision of "Becoming 'the world leader in the non-ferrous metals industry'" and has set out "Vision for 2030" as its milestone to realize the aforementioned Vision. In the "Vision for 2030," 11 issues, in particular, with high impacts, risks or opportunities have been set out as material issues among social challenges extracted, which have been evaluated from the perspectives of both society and businesses in the SMM Group. Then, the "Vision for 2030" at which the SMM Group's initiatives has aimed and KPIs to measure the achievement have been established.

The Sustainability Committee has primarily promoted sustainability activities under initiatives of the management as a sustainability promotion system in the SMM Group who has a total of 16 subcommittees, working groups and committees as subordinate organizations to the Sustainability Committee and a PDCA cycle in which the progress and performance are evaluated and plans for the next fiscal year are reviewed and reconsidered has been executed for the KPIs established for "Vision for 2030."

In December 2023, the SMM Group announced its reduction target for FY 2030 and its roadmap for efforts toward 2050 to achieve net zero greenhouse gas (hereinafter referred to as "GHG") emissions by 2050 as a response to climate change. The roadmap was formulated based on the "International Council on Mining and Metals (hereinafter referred to as "ICMM") Commitments on Climate Change," which was jointly committed in line with the goals of the Paris Agreement by representatives of ICMM member companies, including the Company, in October 2021. These companies have aimed to achieve carbon neutrality by 2050 by introducing new technologies in addition to making the most of existing technologies, such as fuel conversion.

▶▶▶ 3. The Green Finance Framework

The subject of this evaluation is Green Finance Framework (hereinafter referred to as "this Framework") published by SMM to use the proceeds financed through green bonds or green loans (green bonds and green loans are hereinafter collectively referred to as "green finance" only to expenditures to the projects with environmental benefits. JCR will evaluate whether this

Framework has been aligned with the Green Bond Principles¹, the Green Loan Principles², the Green Bond Guidelines³ and the Green Loan Guidelines⁴. These principles and guidelines are voluntarily published by the International Capital Marketing Association (ICMA), Loan Market Association (LMA), etc., and the Ministry of Environment, respectively, and are not legally regulated based on evidence. JCR will however refer to these principles and guidelines as they are referred to as unified standards set domestically and globally at the current moment. JCR will also assess environmental benefits that are referred to "Green Enabling Project Guidance⁵" announced by ICMA in June, 2024.

SMM has limited the proceeds in this Framework exclusively to use for facility expansion to increase production of cathode materials for automotive secondary batteries, construction of new plants and capital investments for recycling lithium-ion secondary batteries. JCR has evaluated that the eligibility criteria established by SMM in this Framework have been highly effective in improving the environment and also key measures that contribute to realizing the Long-Term Vision and "Vision for 2030" formulated by the Company. It has been stipulated that appropriate measures shall be taken in consideration of any negative impacts on the environment and society in implementing eligible projects. Accordingly, JCR has evaluated the use of proceeds in this Framework is expected to improve the environment.

The projects will be selected with departments with specialized knowledge. A management structure has been established to ensure that the proceeds will be allocated to eligible projects. The items to be disclosed as reporting will show their environmental benefits. Accordingly, JCR has evaluated that the management and operation system of SMM has been appropriately established and provided transparency.

Consequently, JCR has assigned "g1(F)" for "Green Evaluation (Use of Proceeds)," "m1(F)" for "Management, Operation and Transparency Evaluation" and "Green 1(F)" for the overall "JCR Green Finance Framework Evaluation" based on JCR Green Finance Evaluation Methodology. This Framework also has met the standards for the items required in the Green Bond Principles, the Green Loan Principles, the Green Bond Guidelines and the Green Loan Guidelines.

¹ ICMA (International Capital Market Association) (2021, with June 2022 Appendix 1) *Green Bond Principles*
<https://www.icmagroup.org/sustainable-finance/the-principles-guidelines-and-handbooks/green-bond-principles-gbp/>

² LMA (Loan Market Association), APLMA (Asia Pacific Loan Market Association), LSTA (Loan Syndications and Trading Association) (2023) *Green Loan Principle*
<https://www.lsta.org/content/green-loan-principles/>

³ Ministry of the Environment (2022) *Green Bond Guidelines*
<https://www.env.go.jp/content/000062495.pdf>

⁴ Ministry of the Environment (2022) *Green Loan Guidelines*
<https://www.env.go.jp/content/000062495.pdf>

⁵ ICMA *Green Enabling Projects Guidance*
https://www.icmagroup.org/sustainable-finance/the-principles-guidelines-and-handbooks/green-enabling-projects-guidance?utm_source=ICMA+Total+Subscribes&utm_campaign=eec2c2e731-EMAIL_CAMPAIGN_2024+Principles+Conference+PR&utm_medium=email&utm_term=0_74a993020a-eec2c2e731-76046178

Table of Contents

■ Evaluation Phase 1: Green Evaluation

I. Use of Proceeds

JCR's Key Consideration in this Factor

Current Status of Evaluation Targets and JCR's Evaluation

1. Environmental Benefits of Projects
2. Negative Impacts on the Environment and Society
3. Alignment with SDGs

■ Evaluation Phase 2: Management, Operation and Transparency Evaluation

I. Selection Standards and Processes for Use of Proceeds

JCR's Key Consideration in this Factor

Current Status of Evaluation Targets and JCR's Evaluation

1. Goals
2. Selection criteria
3. Processes

II. Management of Proceeds

JCR's Key Consideration in this Factor

Current Status of Evaluation Targets and JCR's Evaluation

III. Reporting

JCR's Key Consideration in this Factor

Current Status of Evaluation Targets and JCR's Evaluation

IV. Organizational Environmental Initiatives

JCR's Key Consideration in this Factor

Current Status of Evaluation Targets and JCR's Evaluation

■ Evaluation Phase 3 : Evaluation Result (Conclusion)

I. Use of Proceeds

JCR's Key Consideration in this Factor

In this section, JCR will first confirm whether the proceeds set out in the Framework is used for green projects that have clear environmental benefits. Then, in cases where the use of proceeds is expected to have any negative impacts on the environment and society, JCR will confirm whether these impacts are fully examined by an internal specialist department or an external third party and whether necessary measures have been taken for its workaround and mitigation. Finally, JCR will confirm the alignment with the Sustainable Development Goals (SDGs.)

▶▶▶ Current Status of Evaluation Targets and JCR's Evaluation

Facility expansion to increase production of cathode materials for automotive secondary batteries, construction of new plants and capital expenditures to recycle lithium-ion secondary batteries for which the proceeds will be used by SMM have been significant measures that will contribute to realizing the Long-Term Vision and "Vision for 2030," which are expected to have environmental benefits.

The Framework for Use of Proceeds (Excerpt)

1. Use of Proceeds

The proceeds procured from green bonds or green loans will be allocated to make new investments on new or existing projects that meet the following eligibility criteria (hereinafter referred to as "the eligible projects") or refinance existing investments. In case of refinancing, the proceeds is exclusively limited to expenditures made within the past two years from the procurement through green bonds or green loans.

<Eligibility Criteria>

ICMA's Green Bond Principles Business Category	Eligibility Criteria
Clean transportation	Facility expansion and construction of new plants to increase production of cathode materials for automotive secondary batteries
Circular economy adapted products, production technologies and processes/ pollution prevention and control	Capital expenditures toward recycling lithium-ion secondary batteries

Evaluation by JCR to the Framework

1. Environmental Benefits of Projects

(1) Use of proceeds 1: Facility expansion and construction of new plants to increase the production of cathode materials for automotive secondary batteries

Use of proceeds 1 is exclusively limited to facility expansion to increase the production of cathode materials for automotive secondary batteries and construction of new factories that manufacture materials for these batteries. This project falls under "Clean transportation" in the Green Bond Principles and the Green Loan Principles, and "Projects for clean transportation" exemplified in the Green Bond Guidelines and the Green Loan Guidelines.

<Structure and characteristics of lithium-ion secondary batteries>

Automotive secondary batteries (lithium ion secondary batteries) mainly make carbon-based materials into anode material and make transition metal oxide including lithium ion into cathode material. The principle for operations is that lithium ion is desorbed from cathode material through charging and lithium ion is absorbed to anode material carbon, and electron flows from cathode to anode through this electrochemical reaction, and electric discharge has a reverse reaction to the aforementioned principle.

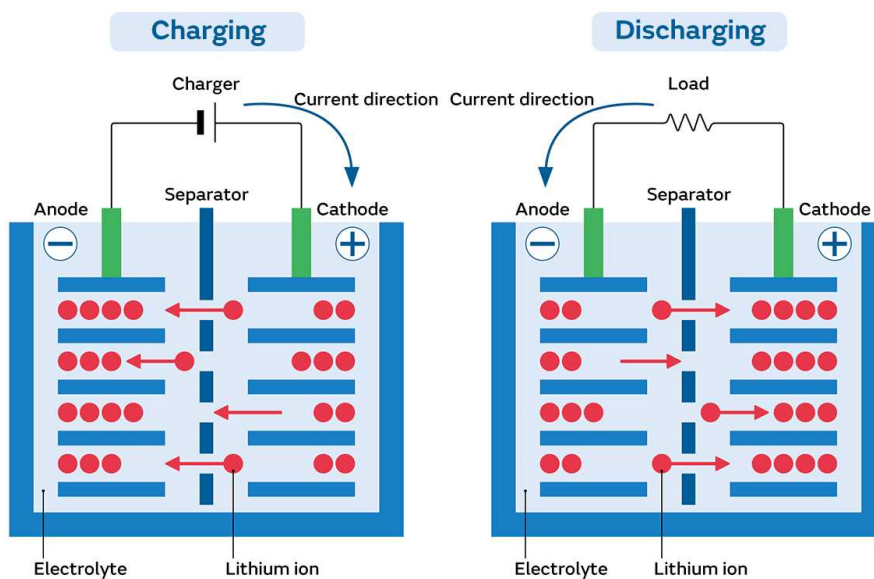

Figure 1: Mechanism for lithium-ion secondary batteries⁶

⁶ Source: Murata Manufacturing Co., Ltd
<https://article.murata.com/en-global/article/basic-lithium-ion-battery-1>

Table 1: Constituent Materials for automotive lithium-ion secondary batteries⁷

	Constituent Materials
Cathode materials	New three-element cathode materials, such as LiCoO ₂ (lithium cobaltate), LiNiO ₂ (lithium nickelate), LiMn ₂ O ₄ (spinel type lithium manganese oxide), LiFePO ₄ (lithium iron phosphate) or Li(Ni _{1/3} Mn _{1/3} Co _{1/3})O ₂
Anode materials	Carbon-based materials, carbon, graphite
Electrolyte solvents	Ethylene carbonate, propylene carbonate, dimethyl carbonate, diethyl carbonate
Electrolyte salt	LiPF ₆ , LiBF ₄
Binder	Polypinylidene Fluoride, SBR, Latex, CMC
Positive current collector	Aluminum foil
Negative current collector	Silver foil

The Company has manufactured nickel-based cathode materials, which are the cathode materials for automotive lithium-ion secondary batteries. Lithium-ion secondary batteries with a rich nickel content ratio have a high energy density and can have a high capacity that allows to have a range; therefore, electric vehicles (hereinafter referred to as "EVs") has a high demand so that EVs can travel long distances. According to Nickel Institute, lithium is, in general, used for batteries as a common denominator due to its light weight and high electrical potential (energy); however, nickel is used in chemical compositions for various lithium-ion batteries, and demand as a product has been on the increase because of the characteristics of nickel.

Rechargeable lithium-ion battery devices have the following technologies and vary depending upon their characteristics:

- Lithium nickel manganese cobalt oxide (NMC cathode)
- Lithium nickel cobalt aluminum oxide (NCA cathode)
- Lithium cobalt oxide (LCO cathode), consumer electronics only
- Lithium iron phosphate (LFP cathode)
- Spinel type lithium manganese oxide (LMO cathode)
- Lithium sulfate (Li-S, sulfuric acid cathode)
- Lithium metal (anode), all solid
- Lithium titanate (LTO anode)

⁷ Nikkei Crosstech

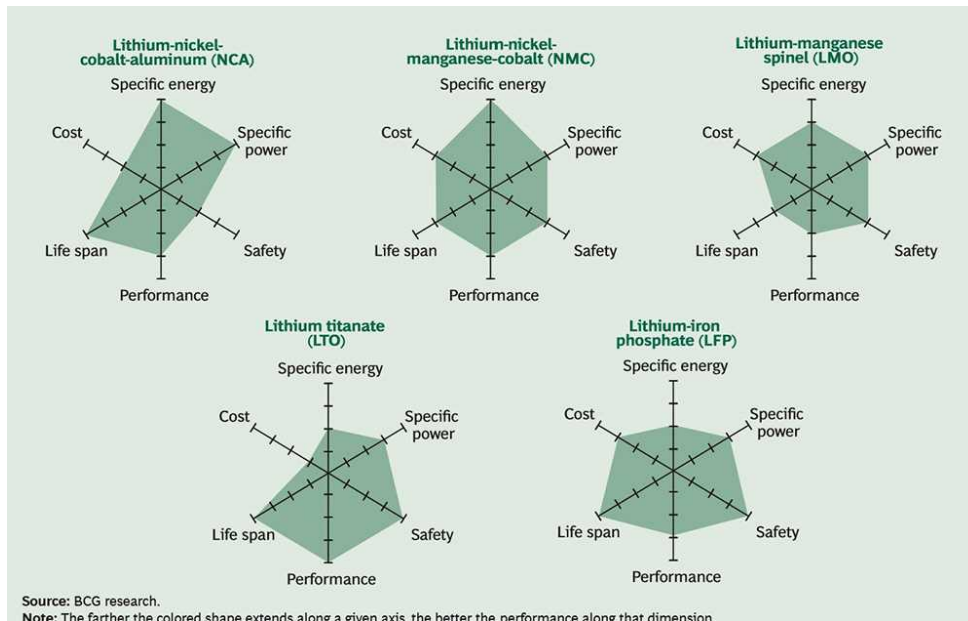

Figure 2: Battery type characteristics

<Demand Forecast for lithium-ion secondary batteries and raw materials>

The International Energy Agency (hereinafter referred to as "IEA") forecasted⁸ that global EV production is expected to increase by 2030 in the STEPS (Stated Policies Scenario: a scenario based on current policies), APS (Announced Pledges Scenario: a scenario based on governmental pledges) and NZE (Net Zero Emissions Scenario: a scenario with the goal of achieving net zero emissions). In the NZE Scenario, the outlook for vehicle sales volume will account for around 65 percent in 2030 and 95 percent in 2035. Then, a demand for automotive lithium-ion secondary batteries used as EV batteries and their raw materials – metal materials, such as copper, lithium, cobalt and nickel, is projected to rapidly increase. IEA has foreseen⁹ that demands for metal materials will increased as follows: copper; up about 1.5 times, lithium; up roughly 8.7 times, nickel; up approximately 2.1 times; and cobalt; up about 2.2 times (from 2023, including applications other than EVs) by 2040.

⁸ IEA *Global EV Outlook 2024 Moving toward Increased Affordability*
<https://iea.blob.core.windows.net/assets/a9e3544b-0b12-4e15-b407-65f5c8ce1b5f/GlobalEVOutlook2024.pdf>

⁹ Source: IEA *Global Critical Minerals Outlook 2024*
<https://iea.blob.core.windows.net/assets/ee01701d-1d5c-4ba8-9df6-abeaac9de99a/GlobalCriticalMineralsOutlook2024.pdf>

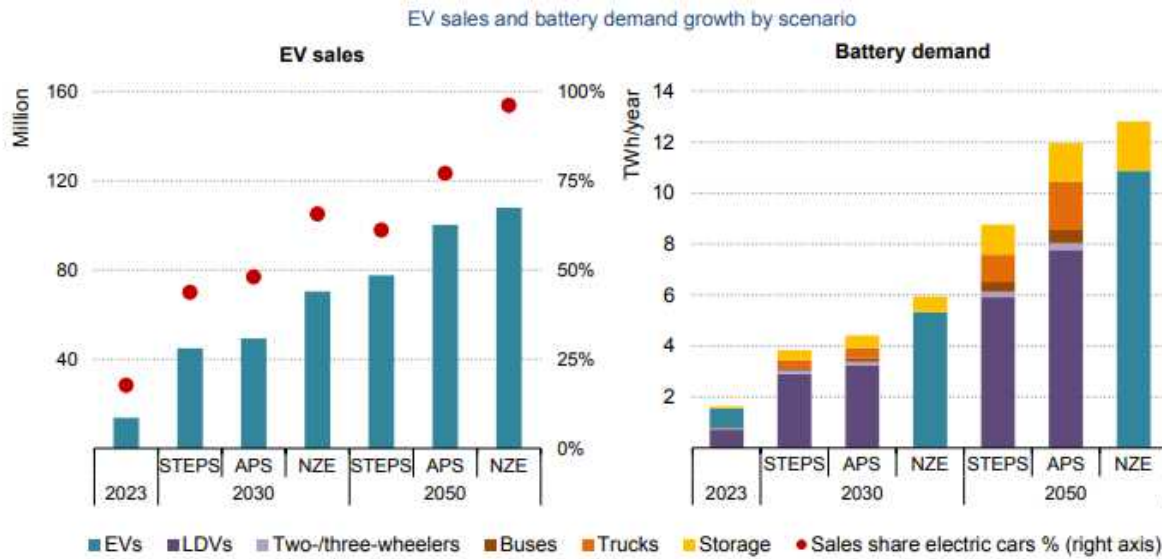

IEA. CC BY 4.0.

Notes: EV = electric vehicle; LDV = light-duty vehicle. EV sales numbers exclude two-/three-wheelers. EV battery demand in the NZE Scenario includes all modes.

Figure 3: EV Sales and Battery Demand Growth Forecasted by IEA¹⁰

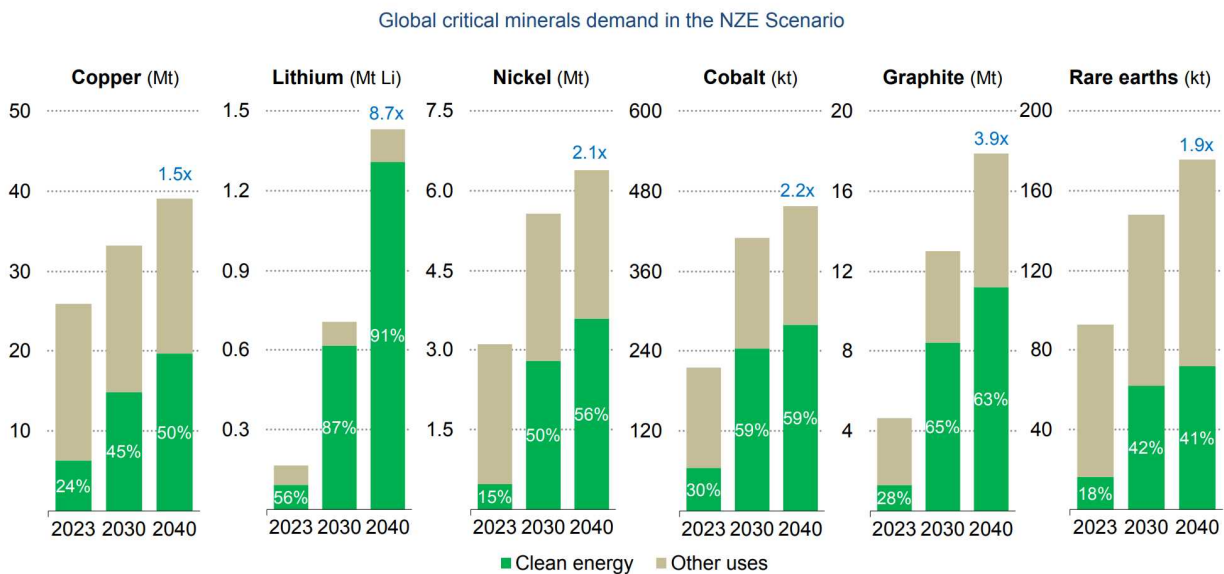

Figure 4: IEA, Global Critical Minerals Demand in the NZE Scenario¹¹

¹⁰Source: IEA Global Critical Minerals Outlook 2024

<https://iea.blob.core.windows.net/assets/ee01701d-1d5c-4ba8-9df6-abeaac9de99a/GlobalCriticalMineralsOutlook2024.pdf>

¹¹Source: IEA Global Critical Minerals Outlook 2024

<https://iea.blob.core.windows.net/assets/ee01701d-1d5c-4ba8-9df6-abeaac9de99a/GlobalCriticalMineralsOutlook2024.pdf>

<SMM's initiatives to increase the production of cathode materials for automotive secondary batteries>

The Company has decided to increase the production of cathode materials for secondary batteries in response to the current situation where automobiles are rapidly electrifying in line with the global decarbonization trend and the demand for automotive secondary batteries has been on the increase. Then, in July 2021, SMM announced that a new factory will be built in the Besshi District (Niihama City, Ehime Prefecture) and facilities will be expanded at the Harima Plant (Harima-cho, Kako-gun, Hyogo Prefecture)¹², which is scheduled to complete in 2025, respectively and the final cathode material production capacity is assumed to be 2,000 tons/month.

SMM has been additionally advantageous that it has its own nickel supply chain from ore to battery materials in an integrated manner. In other words, the Company has enjoyed many advantages, including a stable supply of cathode materials – the end products by (1) securing nickel ore - raw materials; (2) ensuring a stable supply of battery materials through HPAL technology¹³; (3) making stable qualities for cathode materials – the end products by adjusting nickel raw materials that are optimal for battery materials at their smelting stages due to in-house smelting; and (4) reducing costs by lowering energy/work hours through its own supply chain while nickel ore has increasingly become low-grade and the competition has been intensifying.

<Relation to national policy>

The Japanese government set a goal to increase the manufacturing capacity of domestic automotive storage batteries to 100 GWh as soon as possible by 2030 so as to secure a stable foundation for domestic automobile manufacturing in its green growth strategy announced in 2021. Subsequently, the government also established other goals: to establish a domestic manufacturing base of 150 GWh for batteries/materials (including stationary use); and to secure a manufacturing capacity of 600 GWh/year in the global market for the entire Japanese companies (including stationary use) by 2030 in strategies for the battery industry announced in 2022, the "Basic Policy for Realization of GX" and the "Sector-specific Investment Strategies" announced in 2023, respectively. The use of proceeds therefore has been aligned with the government's policies and strategies.

Accordingly, JCR has evaluated that the proceeds will be used for projects with high environmental benefits that contribute to the decarbonization in the automobile industry and for technologies with high impacts in the market.

¹²Sumitomo Metal Mining News Release
https://www.smm.co.jp/news/release/uploaded_files/20210706_E.pdf

¹³SMM successfully commercialized HPAL (High Pressure Acid Leach) – a technology that enabled the recovery of nickel from low-grade nickel oxide ore that had been conventionally difficult to process for the first time in the world. In 2005, the Company has started to produce MS (mixed nickel-cobalt sulfide), an intermediate nickel product, at Coral Bay Nickel Corporation in Palawan Island.

(2) Use of proceeds 2: Capital expenditures to recycle lithium-ion secondary batteries

The use of proceeds 2 refers to capital investments for recycling lithium-ion secondary batteries. This use of proceeds falls into "Circular economy adapted products, production technologies and processes" and "Pollution prevention and control" and "businesses related to the prevention and control of pollution" in the Green Bond Principles and the Green Loan Principles and "Projects for circular economy adapted products, production technologies and processes and eco-efficient products" and "Projects for pollution prevention and control" among the uses of proceeds illustrated in the Green Bond Guidelines and the Green Loan Guidelines.

<Necessity of recycling lithium-ion secondary battery raw materials>

Minerals, such as copper, lithium, cobalt or nickel, which are raw materials for lithium-ion secondary batteries, have been mainly extracted from mines (lithium is extracted from mines and salt lakes). Some concerns have been arisen for these resources, including price hikes or supply difficulties due to a rising demand for lithium-ion secondary batteries for EVs (Figures 3 and 4). A large amount of used lithium-ion secondary batteries may be discarded due to wider availabilities of EVs. Used lithium-ion secondary batteries also contain hazardous substances for which a safe processing structure is required. In cases where ore mined from mines is used as raw materials, it is required to have smelting processes that consume a large amount of energy; therefore, environmental impacts or GHG emissions may increase. It is difficult to accurately compare the GHG emissions from virgin raw materials with those from recycled raw materials due to differences in manufacturing methods; however, a report has shown that when nickel-rich lithium-ion batteries are recycled, the GHG emissions are 28 percent lower than these batteries produced from virgin raw materials.

Total CO₂e battery cell production emissions from a nickel-based lithium-ion battery with virgin versus recycled materials,¹ kgCO₂e per kWh

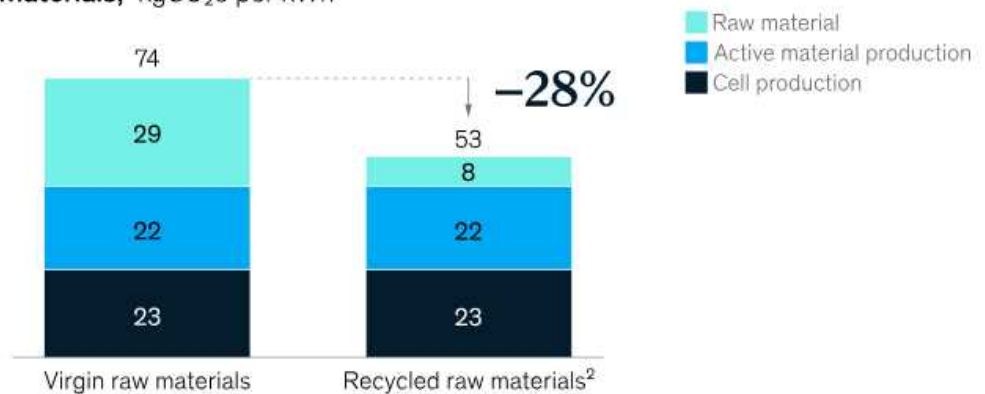

Figure 5: GHG emissions in manufacturing nickel-rich lithium-ion batteries (left: virgin raw material, right: recycled material)¹⁴

¹⁴McKinsey & Company (March 13, 2023) *Battery recycling takes the driver's seat*
<https://www.mckinsey.com/industries/automotive-and-assembly/our-insights/battery-recycling-takes-the-drivers-seat>

Accordingly, a recycling structure in which mineral resources used for lithium-ion secondary batteries can be safely and efficiently recovered. The EU where the circular economy has been promoted as a policy program has already imposed regulations that require to collect lithium-ion secondary batteries and highly recycle battery raw materials.¹⁵

Metal resources in lithium-ion secondary batteries are presently recovered and recycled as alloys; however, these resources cannot have the same quality as the original products and mostly are "cascading recycling" with a decrease in quality. Cascade recycling can also reduce waste; however, it is insufficient to build a recycling-oriented society as metal resources are reused for applications that are less valuable than those before being recycled¹⁶. Therefore, "horizontal recycling" that recycles discarded metals into raw materials with the same quality.

<SMM's Initiatives for Recycling Lithium-Ion Secondary Batteries>

Metal smelting technology are divided into: (1) a pyrometallurgical process that smelt and refines through a heat process; and (2) a hydrometallurgical process that refines metals in an aqueous solution, such as acid, alkali, solvent, etc. Recycling through a pyrometallurgical process is advantageous that discarded lithium-ion secondary batteries can be directly added; however, it is disadvantageous of having a large amount of consuming energy and lithium will be transferred to slag. Meanwhile, in a pyrometallurgical process, cobalt and nickel can be separated, and lithium can also be recovered. The processing process however may be complicated and large amounts of absorbents may be used, which will lead to poor profitability.¹⁷

In 2017, the Company has begun to recycle copper and nickel contained in lithium-ion secondary batteries through a process that combines a pyrometallurgical copper smelting process and a hydrometallurgical refining process, realizing "battery to battery" horizontal recycling of used lithium-ion secondary batteries for the first time in Japan. The Company's lithium-ion secondary battery recycling process enables efficient processing of used lithium-ion secondary batteries with high impurity contents by using its unique technologies that combine pyrometallurgical smelting and hydrometallurgical refining. In 2022, SMM established a technology that recycles lithium from dry slag containing lithium into high-purity compounds, successfully developing a new process for horizontal recycling of copper, nickel, cobalt and lithium through joint development with Kanto Denka Kogyo Co., Ltd. Through such background, in March 2024, the Company announced its plan to construct recycling plants to recover copper, nickel, cobalt and lithium from used lithium iron secondary batteries and other materials on the grounds of the Toyo Smelter & Refinery and the Niihama Nickel Refinery.¹⁸ These plants are scheduled to start their construction in FY 2024 and will be completed in June 2026. The capability of the facilities

¹⁵Regulation (EU) 2023/1542 of the European Parliament and of the Council of 12 July 2023 concerning batteries and waste batteries, amending Directive 2008/98/EC and Regulation (EU) 2019/1020 and repealing Directive 2006/66/EC (Text with EEA relevance)

<https://eur-lex.europa.eu/eli/reg/2023/1542/oj>

¹⁶Japan Oil, Gas and Metals National Corporation 19_03_vol.48 Outline of Lithium Production Technology - Current Status and Future Trends - March 29, 2019 Satoshi Okubo, Production Technology Section, Metal Resources Technology Department

¹⁷ What is a Metal Resource Recycling Society? - To realize "horizontal recycling" by the Institute of Advanced Industrial Science and Technology.

<https://unit.aist.go.jp/env-mri/sure/resycle.html>

¹⁸ SMM Press Release (March 28, 2024) https://www.smm.co.jp/news/release/uploaded_files/20240328_JP.pdf

at these plants, which means the volume of raw materials that can be processed, is planned to be the equivalent of approximately 10,000 tons of lithium-ion- battery cells per year.

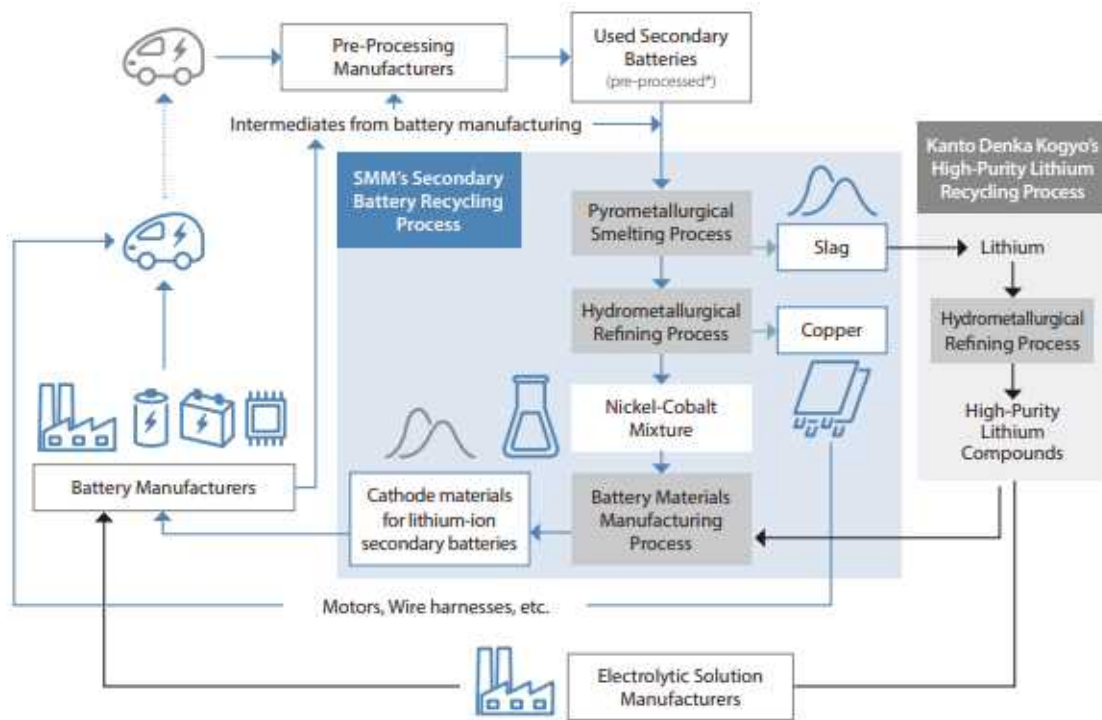

* Pre-processing: Heat treatment to eliminate toxins, crushing, and selection

Figure 6: SMM Overview of Battery to Battery¹⁹

The establishment of a waste collection system has been one of the challenges in the recycling business; however, SMM has signed partnership agreements with leading recycling companies to build a supply chain for used lithium-ion-battery recycling. With this as a spur, the Company shall work together with the partners and accelerate its studies on a collection system for used lithium-ion-batteries. JCR has evaluated that SMM is expected to be effective as a solid collection system will be constructed.

<Relation to national policy>

In the "Basic Policy for Realizing GX (Future Roadmap)" and "Sector-specific Investment Strategies" announced by the Japanese government in 2023, these indicated: (1) a high-level recycling technology for storage batteries shall be established in the storage battery industry; and (2) double the processing amount of metal recycled raw materials (wasted electronic substrates and used storage batteries) in the resource recycling industry as strategies by 2030. In the 5th Fundamental Plan for Establishing a Sound Material-Cycle Society²⁰ decided in the Cabinet in 2024, it showed: (1) a plan to promote resource recycling of metals, such as base

¹⁹ SMM (2024) *Integrated Report*

²⁰Fundamental Plan for Establishing a Sound Material-Cycle Society - Circular Economy as a National Strategy <https://www.env.go.jp/content/000242999.pdf>

metals or rare metals; (2) goals set forth in the aforementioned Future Roadmap; and (3) a target to increase the amount of metal resources, including e-scrap, that contain critical metals to approximately 500,000 tons by 2030 (up 50 percent from 2020). The use of proceeds therefore has been aligned with the Future Pathway and Investment Strategies indicated by the government.

Accordingly, JCR has evaluated that the initiatives to recover battery raw materials directly from lithium-ion secondary batteries for which proceeds will be used, is one of the key solutions to respond to rapid increases in demand for metal resources that are expected to rise further hereafter in considering a transition scenario to clean energy and is greatly contributable to the realization of a recycling-oriented society. JCR has also evaluated that the use of proceeds 2 will have environmental benefits in light of the fact that recycling is expected to reduce GHG emissions.

JCR has also evaluated that the use of proceeds in this Framework with reference to the Green Enabling Project Guidance. The Guidance does not explicitly consider itself green; however, it defines projects needed to realize green projects. JCR has organized that the use of proceeds in this Framework and eligibility requirements in the Guidance above as follows:

Table 2: Organized Eligibility Requirements in Green Enabling Project Guidance²¹

Requirements	Reference	Eligibility
1. Specific eligibility criteria		
1-1. Necessity for the value chain in green projects	Evaluation Phase 1 I. Use of Proceeds 1. Environmental Benefits of Projects	✓
1-2. Avoidance of carbon lock-in	Evaluation Phase 1 I. Use of Proceeds 2. Negative Environmental and Social Impacts	✓
1-3. Clear and quantitative environmental benefits confirmed	Evaluation Phase 2 III. Reporting	✓
1-4. Mitigation in negative social or environmental impacts	Evaluation Phase 1 I. Use of Proceeds 2. Negative Environmental and Social Impacts	✓
2. Transparency of end-users	Evaluation Phase 1 I. Use of Proceeds 1. Environmental Improvement Benefits of Projects	✓
3. Additional guidance		
3-1. Alignment with the Green Bond Principles	Evaluation Phase 1 I. Use of Proceeds 1. Environmental Improvement Benefits of Projects	✓
3-2. Sectors to be Contributed	Evaluation Phase 1 I. Use of Proceeds 1. Environmental Improvement Benefits of Projects	✓
3-3. Avoidance of double counting in impact reporting	Evaluation Phase 2 I. Selection Criteria and Processes for Use of Proceeds	✓

²¹Prepared by JCR

2. Negative Impacts on the Environment and Society

This Framework for Initiatives to Reduce Environmental and Social Risks

Initiatives to Reduce Environmental and Social Risks

The Group has confirmed that all target projects have responded to the following items so as to reduce environmental risks in selecting the use of proceeds.

- Comply with environment-related laws and regulations in the national and local governments where projects have been carried out and conduct an environmental assessment where appropriate
- Improve facilities without serious environmental accidents
- Rational use of water and reduce emissions of hazardous substances that flow into the air and water

The Group has built a management system in accordance with international standards or human rights policies so as to reduce social risks and has taken the following measures for "employees," "local residents" and "supply chain."

Employees	The Group has valued every one of its diverse employees and has strived to create a work environment where they can demonstrate their abilities in line with "Diverse Human Resources" and "Development and Participation of Human Resources," which are the key issues of "Vision for 2030."
Local Residents	The Group has accurately grasped local issues through communications with local communities and has been working on "Support for nurturing of the next generation" and "Support for people with disabilities and the elderly" in line with "Co-Existence and Mutual Prosperity with Local Communities," which is an important issue of "Vision for 2030."
Supply Chain	The Group has been working on due diligence based on international standards in accordance with "SMM Group Sustainable Procurement Policy" and "SMM Group Source minerals responsibly."

Evaluation by JCR to the Framework

In addition to the aforementioned, JCR confirmed through interviews with SMM that it will secure employees' safety, in particular, paying attention to the followings in plants where cathode materials for automotive secondary batteries have been manufactured for which the proceeds 1 will be used in this Framework:

- The Company plans to make a safer design in new plants than existing plants in order for workers to be less disposed to metallic dust during respective stages of raw materials, semi-finished goods and products and reduce their workloads by: heavily forwarding the products (dust) between manufacturing facilities; and promoting automated packaging.
- SMM will additionally design facilities or provide operators safety education by following safety standards, including safety measures already taken, in existing plants and at the same time it will provide new trainees with preliminary training in existing factories for one to two years, instead of letting them work as they are and then they will be adequately deployed after safety education and operating training are undergone.
- The Company plans to lower risks upon startup by appropriately assigning and deploying managers who have experienced at existing factories.

The use of proceeds 2: Measures in recycling plants for lithium-ion secondary batteries are as follows:

- This recycling plant will be built in an existing factory and measures will be taken in line with the occupational safety policies at existing plant so as to ensure workers' safety.
- The Company plans to carry out assessments so as to comply with domestic environmental laws and regulations in buildings this recycling plant.
- The main raw material, black mass that is a concentrate obtained by eliminating toxins from used lithium-ion secondary batteries with heat treatment, crushing and selecting, contains substances that are harmful to the environment in addition to nickel, cobalt, copper and lithium, which are used as raw materials for cathode materials. In this process, the SMM has planned to curb the increase in waste by making maximum use as items of value in in a detoxified and safe fashion.

SMM has held the Occupational Health and Safety Committee at each plant and strived to maintain and improve safety on work. Additionally, all of the proceeds will be used as parts and materials for lithium-ion secondary batteries for EVs without fossil fuels during travelling and will not lock in GHG emissions. Accordingly, JCR has evaluated that the Company has adequately identified and addressed negative environmental and social impacts.

3. Alignment with SDGs

JCR has evaluated the use of proceeds set out in this Framework will contribute to the following SDGs' goals and targets with reference to ICMA's SDGs mapping.



Goal 9: Industry, Innovation and Infrastructure

Target 9.4. By 2030, upgrade infrastructure and retrofit industries to make them sustainable, with increased resource-use efficiency and greater adoption of clean and environmentally sound technologies and industrial processes, with all countries taking action in accordance with their respective capabilities



Goal 11: Sustainable cities and communities

Target 11.2 By 2030, provide access to safe, affordable, accessible and sustainable transport systems for all, improving road safety, notably by expanding public transport, with special attention to the needs of those in vulnerable situations, women, children, persons with disabilities and older persons
Target 11.6. By 2030, reduce the adverse per capita environmental impact of cities, including by paying special attention to air quality and municipal and other waste management



Goal 12: Responsible Consumption and Production

Target 12.5. By 2030, substantially reduce waste generation through prevention, reduction, recycling and reuse



Goal 13: Climate Action

Target 13.1. Strengthen resilience and adaptive capacity to climate-related hazards and natural disasters in all countries

I. Selection Standards and Processes for Use of Proceeds

JCR's Key Consideration in this Factor

In this section, JCR will confirm that the objectives to be achieved through green financing, the appropriateness of green project selection standards and processes, and whether or not a series of processes will be properly disclosed to investors/lenders and others.

▶▶▶ Current Status of Evaluation Targets and JCR's Evaluation

JCR has determined that departments with special knowledge and the management have been adequately involved in the targets, selection standards of green projects and processes in this Framework and that transparency has been secured.

1. Goals

The Framework for Goals

2. SMM's Long-Term Vision and Vision for 2030

The Group has set forth its Long-Term Vision of "Becoming 'the world leader in the non-ferrous metals industry'" under the aforementioned corporate philosophy and has defined "the world leader in the non-ferrous metals industry" for which the Group has intended as follows:

- Has a global presence in terms of mineral resource interests or metal production volumes (= be in the global top five)
- Has leading technologies or a unique business model that cannot be easily emulated by other major mineral resource companies
- Grows sustainably and stably produces a certain amount of profit
- Actively tackles social issues, such as the SDGs
- Has employees work with spirit

The Group has set out "Vision for 2030" as a milestone to realize this long-term vision. The Group has set out eleven issues with particularly high impacts, risks and opportunities as material issues among the social issues identified by evaluating from the both perspectives of society and its businesses. For respective key issues, the Group has established: (1) "Ideal Vision" at which the initiatives aim; (2) "Vision for 2030" as an ideal figure recognized as such by society; and (3) a KPI to measure the degree of achievement.

<11 Key issues and "Vision for 2030">

Material Issues		Vision for 2030 and The Background
1	Effective use of non-ferrous metal resources	<ul style="list-style-type: none"> • A company that generates resources through high technological capabilities The SMM Group is engaged in the mining of natural resources, the production of highly advanced materials, and everything in between. The Group handles a wide range of non-ferrous metal materials in the process. The Group believes that it is its responsibility to take on the challenge of making more effective use of limited non-ferrous metal resources without waste through the utilization of resources that could hitherto not be used due to technical obstacles and through the development of recycling technologies.
2	Climate change	<ul style="list-style-type: none"> • A company that actively undertakes climate change countermeasures, by reducing emissions and stably supplying products contributing to a low-carbon society, a future with zero GHG Society's demand for companies to reduce GHG emissions has increased dramatically, and the business risks associated with climate change are also increasing. On the other hand, a stable supply of products contributing to a low-carbon society, such as the secondary battery materials for EVs and the near-infrared absorbing materials both produced by the Group, are expected to contribute to the reduction of GHG emissions.
3	Significant Environmental Accidents	<ul style="list-style-type: none"> • A company that values water resources and biodiversity, and protects the richness of the sea and land The SMM Group recognizes that there are risks of adverse impacts on the natural environment when developing natural resources and using chemical substances. In addition to preventing significant environmental accidents, it recognizes that minimizing its negative environmental impacts, including rationalization of the use of water, and preserving biodiversity in its day-to-day management of operations are prerequisites for business continuity.
4	Biodiversity	
5	Employees' Occupational Health and Safety	<ul style="list-style-type: none"> • A company where all employees work together with safety first the priority in a comfortable working environment as well as safe facilities and operations It is the responsibility of management to prevent work-related accidents and illnesses, provide a safe, healthy and comfortable work environment and strive to improve employee comfort. All of these also lead to greater motivation and productivity among employees. The SMM Group bases management on job classification, striving to ensure the safety and health of its employees through intrinsic equipment safety improvements and safety education.
6	Diverse human resources	<ul style="list-style-type: none"> • A company where all employees can take a vibrant and active part The source of the SMM Group's growth is its employees. The Group respects individuality and diversity and aims to create an open and vibrant organizational climate in which everyone can demonstrate their strengths and thrive. With the globalization of business and the rapid development of DX, it is a management challenge to develop human resources who can think and act on their own initiative based on their expertise.
7	Development and Participation of Human Resources	
8	Dialogue with stakeholders	<ul style="list-style-type: none"> • A company that is appreciated and understood to be the world leader in non-ferrous metals industry • A company that contributes to regional development and earns trust as a member of the local community • A company that understands and respects the traditions and culture of indigenous peoples <p>The SMM Group's main premise for business continuity is to earn a social license to operate. To this end, the Group recognizes the importance of promoting information</p>
9	Co-Existence and Mutual Prosperity with Local Communities	

10	<p>Rights of Indigenous Peoples</p>	<p>disclosure and transparency to the greatest extent possible, as well as deepening mutual understanding and building relationships of trust through ongoing dialogue with local communities and other stakeholders. In particular, when there is a risk that development may affect the livelihood of indigenous peoples, the Group gains a thorough understanding of its culture, traditions and history and engages in a continuing dialogue prior to development. It is then necessary to proceed carefully to prevent such impacts of development.</p>
11	<p>Human Rights in the Supply Chain</p>	<ul style="list-style-type: none"> • A company that undertakes sustainable procurement across the supply chain <p>As for Business and Human Rights, the calls for companies to take strong measures to prevent human rights violations throughout the Group's supply chains are increasing. It is necessary for the SMM Group to construct sustainable supply chains in collaboration with business partners to prevent its business activities from having negative impacts on human rights along its diverse supply chains.</p>

<Achievement Image>

The World Leader in the Non-Ferrous Industry

The SMM Group defines "the World Leader in the Non-Ferrous Industry" as follows:

- Have a global presence in terms of mineral resource interests and metal production volumes
(= be in the global top five)
- Have leading technology and a unique business model that cannot be easily emulated by other major mineral resource companies
- Grow sustainably and stably produce a certain amount of profit
- Actively tackle social issues such as the SDGs
- Have employees work with spirit

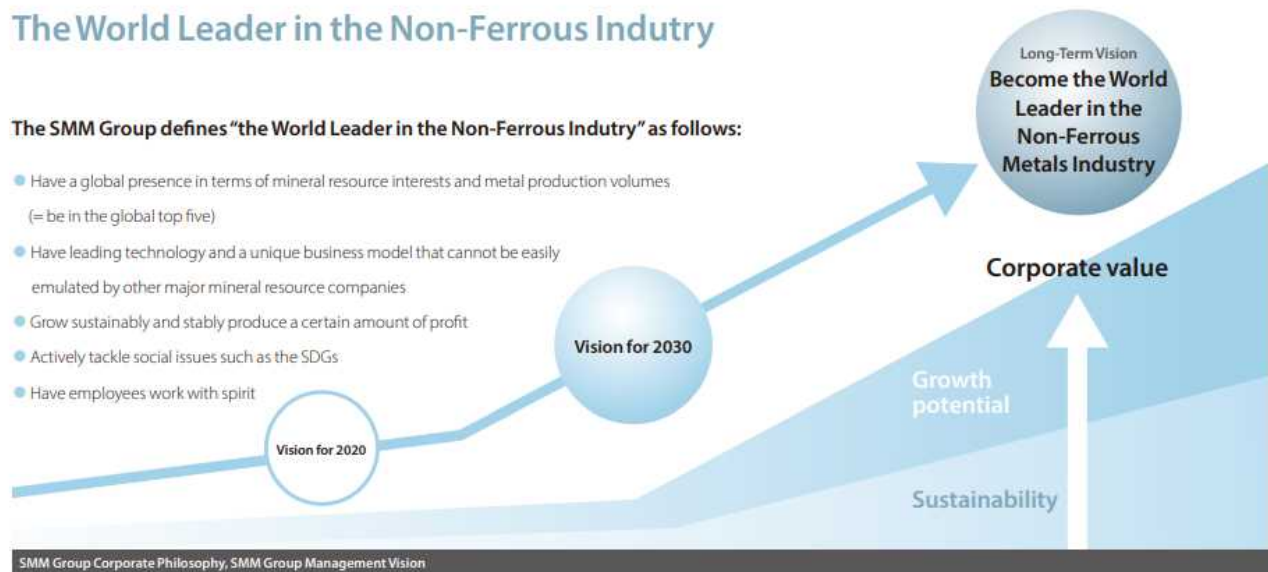

SMM Group Corporate Philosophy, SMM Group Management Vision

The Group will expand its growth potential and sustainability, increase its corporate value and realize its Long-Term Vision by promoting to achieve "Vision for 2030."

Evaluation by JCR to the Framework

This use of proceeds set out in this Framework refers to initiatives that contribute to realizing: (1) "A company that generates resources through high technological capabilities" in "Effective Use of Non-Ferrous Metal Resources"; and (2) "A company that actively undertakes climate change countermeasures, by reducing emissions and stably supplying products contributing to a low-carbon society, a future with zero GHGs" in "Climate Change" among key issues of SMM's "Vision for 2030." All of the four challenges in the 3-Year Business Plan are efforts that contribute to "Adapting to changes in the social environment" and the use of proceeds 1 has been positioned as major measures that contribute to "Increasing corporate value – Promotion of large-scale projects," and the use of proceeds 2 has been positioned as major measures that contributes to "Improving core business sustainability."

The SMM Group has aimed to become the world leader in the non-ferrous metals industry as its Long-Term Vision. Its business model is characterized by 3-business collaboration between non-ferrous metal operating companies that are globally unique. The 3-business refers to: (1) Mineral Resources Business who has developed and operated mines in a way that is considerate to the environment and society; (2) Smelting & Refining Business who has generated high-quality metal materials from the extracted ores; and (3) Materials Business who has added new value to these materials that meet the needs of the times. JCR has evaluated that the SMM Group's 3-business collaboration has covered from resource development to smelting & refining and production of functional materials in a consistent fashion and has also utilized for the production of cathode materials for automotive secondary batteries and recycling of lithium-ion secondary batteries for which the proceeds will be used in this Framework, which are major axes for the SMM Group to improve its long-term corporate value and simultaneously important initiatives to maintain its competitive advantages.



Figure 7: SMM's Unique 3-business Collaboration Model²²

²² Source: SMM's website
<https://www.smm.co.jp/en/business/>

Accordingly, JCR has evaluated that the businesses covered by this Framework have been aligned with the SMM Group's environmental targets and contributed to increasing its long-term its corporate value.

2. Selection criteria

The eligibility criteria in this Framework are described in Evaluation Phase 1 of this report. JCR has assessed that the selection criteria for the project have been appropriate.

3. Processes

The Framework for Processes

2. Process for Project Evaluation and Selection

Process for Project Selection

Projects for which proceeds will be allocated will be selected by the Finance & Accounting Dept., with the support of the Sustainability Dept. based on the compliance with the eligibility criteria established above, and the final decision will be made by the executive officer in charge of Finance & Accounting Dept.

Evaluation by JCR to the Framework

JCR has confirmed that the Company will select green eligible projects as follows: (1) Business Division in charge will scrutinize plans for capital expenditures based on whether capital investments will be contributable to only respective projects for which proceeds will be used; (2) Sustainability Dept. will confirm these plans have more environmental benefits than negative impacts; (3) Finance & Accounting Dept. will select candidates and formulate policies to finance proceeds; and then (5) the executive officer in charge of the Finance & Accounting Dept. will make a final decision for specific funding methods and allocation. The responsible Business Division who will calculate the environmental benefits for the use of proceeds 1 is Battery Materials Div. with the support by Energy & Green Transformation Dept. The use of proceeds 2 will be in charge by Non-Ferrous Metals Div.

The goals, selection criteria and processes of the Company defined in this Framework have been appropriately established. SMM will specify the targets, selection criteria and processes as the requirements to be satisfied by green finance on the framework, will disclose the written framework on its website and will explain the details to investors through amended shelf registration statements and supplementary documents to the shelf registration statements; therefore, transparency has been ensured.

II. Management of Proceeds

JCR's Key Consideration in this Factor

It is usually assumed that the management of proceeds varies widely depending on issuers/borrowers. JCR will confirm whether the proceeds are appropriated exclusively to green projects and whether a mechanism and internal system are in place to make tracking easy.

JCR also will focus on whether the proceeds are scheduled to be used for green projects at an early stage and the management and operation methods for unallocated proceeds.

▶▶▶ Current Status of Evaluation Targets and JCR's Evaluation

JCR has evaluated that SMM has adequately established its proceeds management system and that how to manage the proceeds has been highly transparent as it will be disclosed in this evaluation report and the framework will be released on the website.

The Framework for Management of Proceeds

3. Management of Proceeds

The proceeds raised through green bonds or green loans will be managed after Finance & Accounting Dept. shares the allocation to eligible projects with the relevant departments. Business Division in charge will quarterly track and manage the proceeds so that the equivalent amount of the proceeds procured for green financing can be allocated to eligible projects through an internal accounting system. The unappropriated proceeds will be managed in cash or cash equivalents.

Evaluation by JCR to the Framework

SMM will manage the allocation of proceeds procured through green finance after sharing that effect with Finance & Accounting Dept. and related departments as described in the above-mentioned framework. Proceeds raised through green finance will be managed in safe and highly liquid assets, such as cash or cash equivalents, until all proceeds are appropriated to eligible projects. JCR has evaluated that SMM has secured its internal control system to a certain extent although internal/external audit will not be provided to its internal accounting system because: (1) the responsible Business Division will be tracked and managed via the internal accounting system on a quarterly basis; and (2) General Manager of the Finance & Accounting Dept. will give a final approval in an annual external disclosure after Finance & Accounting Dept. will quarterly confirm the details once every quarter. The allocation of proceeds will be recorded for the same period as bonds and loans will be stored.

Accordingly, JCR has evaluated that the Company has provided high transparency as its proceeds management system has been properly established and that how to manage proceeds will be disclosed in this evaluation report.

III. Reporting

JCR's Key Consideration in this Factor

In this section, JCR will evaluate whether the disclosure system for investors/lenders before and after financing based on the Framework, is planned in detail and in an effective manner.

▶▶▶ Current Status of Evaluation Targets and JCR's Evaluation

JCR will evaluate that SMM's reporting will be appropriately disclosed to investors for both the allocation of proceeds and environmental benefits.

The Framework for Reporting

4. Reporting

Allocation Reporting

Information on the following allocation will be annually disclosed on the Company's website until the proceeds financed through green bonds or green loans are fully allocated to eligible projects.

- (1) Amount allocated
- (2) Amount of unallocated
- (3) Approximation or percentage allocated to refinancing

Impact Reporting

SMM will annually disclose the information based on the following matrices on its website to the extent practicable as long as there is a balance of green bonds and green loans.

Project Categories for ICMA Green Bond Principles	Eligibility Criteria	Impact Reporting Metrics
Clean transportation	Facility expansion to increase production of cathode materials for automotive secondary batteries and construction of new plants	Annual production capacity (t) of nickel-based cathode materials in eligible projects Estimates of contribution of GHG reduction* ² by products contributing to a low-carbon society (t-CO ₂) (in a phase disclosable)
Circular economy adapted products, production technologies and processes/pollution prevention and control	Capital investments to recycle lithium-ion secondary batteries	Actual data of the volume of raw materials in a lithium-ion secondary battery recycling plant (equivalent to lithium-ion secondary battery cell)

*² Based on the Group's total production, including those produced in eligible projects

Evaluation by JCR to the Framework

JCR has evaluated that the above-cited reporting will be properly disclosed to investors for both the allocation of proceeds and environmental benefits.

Allocation Reporting

SMM will yearly disclose the details defined for the allocation of proceeds raised through green finance in this Framework on its website. In cases where there is any major change in the proceeds allocation plan, and if there are unallocated proceeds, the contents will be disclosed in a similar fashion.

Environmental Benefits Reporting

The Company will annually release environmental benefits set out in this Framework as reporting items for environmental benefits as long as there is any balance of bonds or loans. After disclosure was made for a formula for the GHG reduction contribution that is assumed as a reporting item for the use of proceeds 1 by SMM, JCR has confirmed the formula is adequate. The actual data on the volume of raw materials processed (equivalent of lithium-ion secondary battery cells) in the lithium-ion secondary battery recycling plant, which is a reporting item for the use of proceeds 2 have indicated an absolute value of recycled waste before and after such project. JCR has evaluated that the items and frequency to be disclosed stipulated in this reporting plan have been adequate metrics so as to indicate environmental benefits of the use of proceeds.

Accordingly, JCR has evaluated that the Company's reporting system has been appropriate.

IV. Organizational Sustainability Initiatives

JCR's Key Consideration in this Factor

In this section, JCR will evaluate whether the management of the issuer/borrower has positioned sustainability issues as a high priority for management and whether the sustainability policy, process and selection criteria for green projects have been clearly positioned through the establishment of a department specializing in environmental issues or in collaboration with external organizations.

▶▶▶ Current Status of Evaluation Targets and JCR's Evaluation

JCR has highly evaluated that SMM has positioned sustainability issues as key management challenges, has had a council on sustainability issues and has made efforts from a practical and administrative perspective while taking in the knowledge and expertise from both internal operational departments and external experts.

The SMM Group's corporate philosophy, management vision and sustainability policy are as follows:

[Group Corporate Philosophy]

SMM in accordance with the Sumitomo Business Spirit, shall, through the performance of sound corporate activities and the promotion of sustainable co-existence with the global environment, seek to make positive contributions to society and to fulfill its responsibilities to its stakeholders, in order to win ever greater trust. SMM shall, based on respect for all individuals and recognizing each person's dignity and value, seek to be a forward-minded and vibrant company.

[Management Vision]

By improving technical capabilities, SMM shall fulfill its social responsibilities as a manufacturing enterprise. Based on the principles of compliance, environmental protection and operational safety, the SMM Group shall pursue maximum corporate value through the securing of resources and the provision of high-quality materials, such as non-ferrous metals and advanced materials via its global network.

[SMM Group Sustainability Policy]

The SMM Group will tackle management issues that contribute to society's sustainable development and will strive to achieve continuous growth in its business and improve its corporate value.

The SMM Group has set forth "Becoming 'the world leader in the non-ferrous metals industry'" as its Long-Term Vision under the aforementioned corporate philosophy, and it has defined: (1) 11 significant issues; (2) "Vision for 2030"; and (3) the KPIs to measure the achievement degree so as to achieve the above-cited Vision (refer to 1. Goals, under Evaluation Phase 2 I. Selection Criteria and Processes for Use of Proceeds).

The Company also declared to achieve carbon neutrality by 2050 as a policy to reduce GHG in accordance with ICMM's policy. In December 2023, SMM announced to take actions to reduce GHG emissions by at least 38 percent (at least 50 percent in Japan and at least 24 percent overseas) compared to FY 2015 and achieve net zero GHG emissions by 2050. This roadmap was formulated based on ICMM Climate Change Statement, which was jointly committed by representatives of ICMM member companies in line with the goals of the Paris Agreement in October 2021, and the target for FY 2030 is well below 2°C level of the SBTi (a reduction rate: - 2.5 percent/year).²³

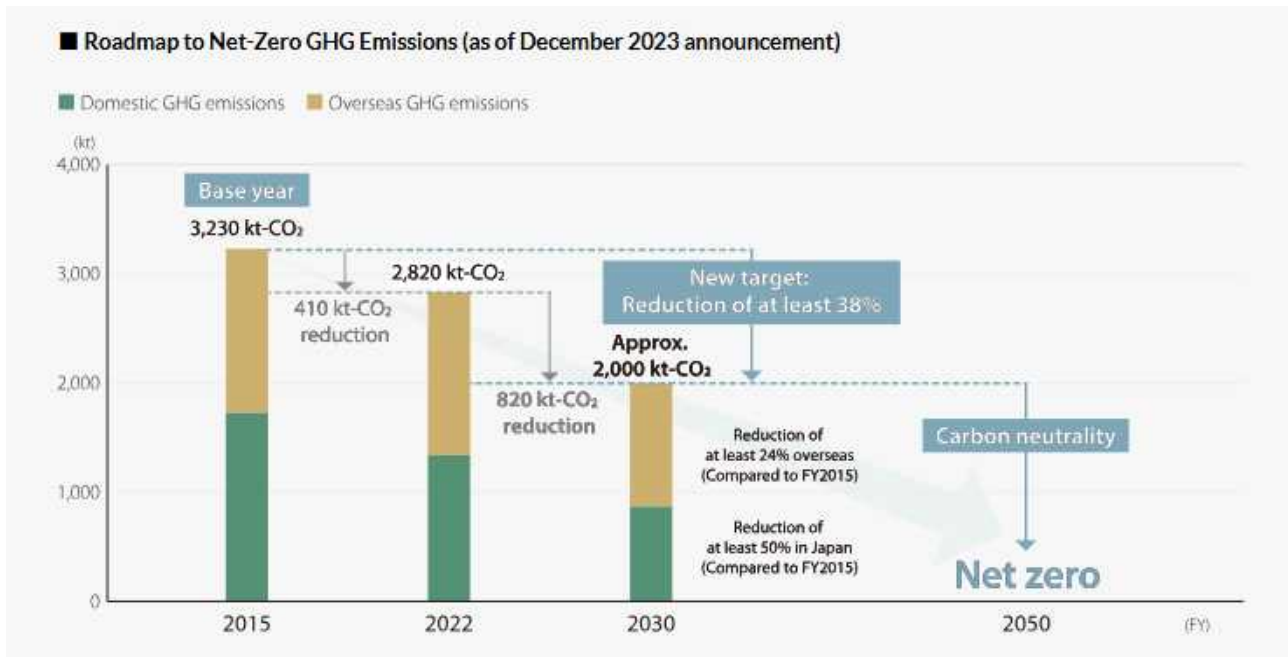

Figure 8: Roadmap toward Carbon Neutrality by 2050²⁴

Smelting & Refining Business who has consumed a large amount of fossil fuels, such as coal and heavy oil, or electricity has mostly accounted for GHG emissions in the SMM Group. The barrier that prevents Smelting & Refining Business from reducing GHG emissions is a method without GHG emissions is technically and economically unavailable for the moment. As shown in the Figure below, the Group is presently making maximum use of existing technologies, such as energy conservation and fuel conversion and are aiming to realize carbon neutrality by 2050 by introducing innovative technologies that are expected to be implemented from 2030 onward.

²³ICMM "ICMM CLIMATE CHANGE STATEMENT"
<https://www.icmm.com/en-gb/our-work/environmental-resilience/climate-change/net-zero-commitment>

²⁴Source: SMM website
https://www.smm.co.jp/en/sustainability/management/climate/climate_3.html

	Action up to FY2022	Action until FY2030	Action until FY2050
Process improvements	Energy conservation and increases in efficiency Reconstruction of production processes (Harima Refinery, Hyuga Smelting, and other sites)	Maximum utilization of available technologies	
		Comprehensive energy conservation and increases in efficiency	
Energy transition	Transition from heavy oil to LNG (Isoura Plant and Niihama Nickel Refinery) Introduction of solar and geothermal binary power generation (Hishikari Mine, Ome District Division, and other sites)	Expansion of transition from heavy oil and coal to LNG and woody biomass fuel	Ongoing initiatives
		Electrification of equipment that uses heat Expanded introduction of renewable electric power Utilization of carbon credits	
Improvement of the emission factors for procured electric power	Switch to renewable energy (Harima Refinery, Hishikari Mine)	Expanded use of renewable energy Use of renewable energy certificates	Introduction of new technologies
Technology development	Exploratory and basic research	Pilot tests and verification tests	
Utilization of outside technologies		Investigation and preparation of new technology applications	Use of green hydrogen, green ammonia, and synthetic methane CO ₂ separation, capture, and storage technology (CCUS)

Figure 9: Initiatives for Carbon Neutrality by 2050²⁵

The SMM Group has established seven Sustainability Subcommittees and four Management System Working Groups to proactively work toward the achievement of material issues, respective KPIs and GHG emission reduction targets. The seven Sustainability Subcommittees have been in charge of promoting respective key issues and Ideal Vision and have managed the formulation and implementation of annual targets in line with KPIs and have reported the activities made to the Sustainability Promotion Committee twice a year. The Sustainability Dept. has created booklets with detailed explanations related to sustainability in an easy-to-understand manner and distributed these booklets to respective employees, contributing to fostering awareness of sustainability so as to make these departments and employees understand sustainability.

In April 2022, the Group established the Carbon Neutrality Committee, in particular, for climate change, which is separated from the Environmental Preservation Subcommittee who has handled Significant Environmental Accidents/Biodiversity. The Carbon Neutrality Promotion Committee will be basically working with respective Business Divisions and organizations related to carbon neutrality in an integrated fashion based on the SMM Group Corporate Philosophy,

²⁵ Source: SMM website
https://www.smm.co.jp/en/sustainability/management/climate/climate_3.html

SMM Group Management Vision and Vision for 2030 with the aim of all parties actively working on depending upon their roles. Detailed deliberations and decisions made at the Carbon Neutrality Committee will be reported to the Sustainability Committee that is held roughly twice a year, and the detailed deliberations and decisions will be discussed and approved and then reported in the Board of Directors. Energy & Green Transformation Dept. who will support to calculate the environmental benefits for the use of proceeds in this Framework refers to the Secretariat of the Carbon Neutrality Committee.

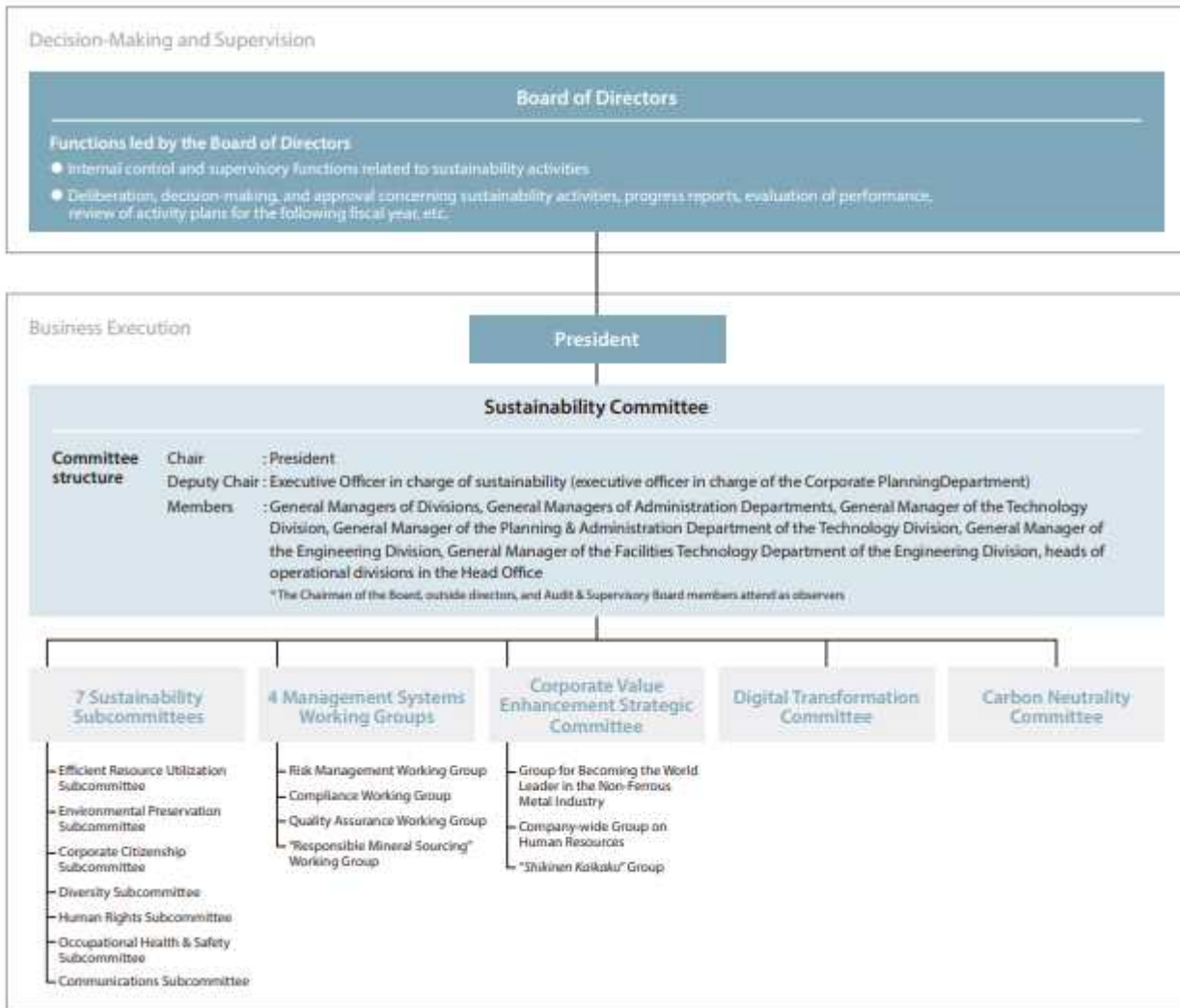

Figure 10: SMM Group's Sustainability Promotion Structure²⁶

The Company has exchanged opinions on sustainability issues with external experts or been supported from these experts. SMM cooperated with attorneys who have sufficient knowledge of human rights issues and ILO Office in Japan for Policy on Human Rights revised and issued on June 1, 2022 for instance. SMM worked on significant review for Ideal Vision formulated in 2014 and 2019, respectively, with support by an audit firm with a deep understanding of the Company. The environmental benefits of projects for which proceeds will be used in this

²⁶SMM Integrated Report 2024

Framework will be discussed and decided with in-house experts or related parties, led by the Carbon Neutrality Committee.

Accordingly, the management has positioned sustainability issues as highly prioritized management challenges, and JCR has evaluated that internal and external experts with specialized knowledge have been involved in sustainability initiatives, including the environment, as an organization.

Evaluation phase 3: Evaluation Result (Conclusion)

Green 1(F)

JCR assigned "g1(F)" for the "Green Evaluation (Uses of Proceeds)" and "m1(F)" for the "Management, Operation and Transparency Evaluation" based on JCR Green Finance Evaluation Methodology. As a result, JCR assigned "Green 1(F)" for the "JCR Green Finance Framework Evaluation." This Framework meets the standards for the items required in the Green Bond Principles, the Green Loan Principles, the Green Bond Guidelines and the Green Loan Guidelines.

		Management, Operation, and Transparency Evaluation				
		m1(F)	m2(F)	m3(F)	m4(F)	m5(F)
Green Evaluation	g1(F)	Green 1(F)	Green 2(F)	Green 3(F)	Green 4(F)	Green 5(F)
	g2(F)	Green 2(F)	Green 2(F)	Green 3(F)	Green 4(F)	Green 5(F)
	g3(F)	Green 3(F)	Green 3(F)	Green 4(F)	Green 5(F)	N/A
	g4(F)	Green 4(F)	Green 4(F)	Green 5(F)	N/A	N/A
	g5(F)	Green 5(F)	Green 5(F)	N/A	N/A	N/A

(Responsible analysts for this evaluation) Atsuko Kajiwara, Haruna Goto

Important explanations of this Evaluation

1. Assumptions, Significance and Limitations of JCR Green Finance Framework Evaluation

JCR Green Finance Framework Evaluation, which is determined and provided by Japan Credit Rating Agency, Ltd. (JCR), covers the policies set out in the Green Finance Framework, and expresses JCR's comprehensive opinion at this time regarding the appropriateness of the Green Project as defined by JCR and the extent of management, operation and transparency initiatives related to the use of funds and other matters. Therefore, JCR Green Finance Framework Evaluation is not intended to evaluate the effects of specific environmental improvements and the management, operation and transparency of individual bonds and borrowings, etc. to be implemented based on these policies. In the event an individual bond or individual borrowing based on this Framework is subject to a green finance evaluation, a separate evaluation is needed. JCR Green Finance Framework Evaluation does not prove the environmental improvement effects of individual bonds or borrowings implemented under this Framework, and does not assume responsibility for their environmental improvement effects. JCR confirms the environmental improvement effects of funds procured under the Green Finance Framework measured quantitatively and qualitatively by the issuer/borrower or by a third party nominated by the issuer/borrower, but in principle it does not directly measure such effects.

2. Methodology used in this evaluation

The methodology used in this assessment are described in "JCR Green Finance Evaluation" on the "Sustainable Finance ESG" section of the JCR website (<https://www.jcr.co.jp/en>).

3. Relation with Conduct of Credit Rating Activities

JCR Green Finance Framework Evaluation is determined and provided by JCR as a related business, which is different from its activities related to the credit rating business.

4. Relation with Credit Rating

The Evaluation is different from the Credit Rating and does not assure to provide or browse a predetermined credit rating.

5. Impartiality in Evaluating JCR Green Finance Framework Evaluation

There are no capital and/or personnel relationships that may result in a conflict of interests between the subject of this evaluation and JCR.

■Disclaimer

The information contained in this document was obtained by JCR from the issuer/borrower and from accurate and reliable sources; however, such information may be mistaken for human and/mechanical errors or other reasons. Therefore, JCR makes no representation or warranty, whether express or implied, as to the accuracy, result, appropriateness, timeliness, completeness, marketability or fittingness for any particular purpose of such information, and assumes no responsibility for any errors, omissions or consequences of using such information. JCR shall not be liable for any loss of opportunity and extraordinary, indirect, incidental or consequential damages of any kind, including any loss of money, which may result from any use of such information under any circumstances, whether contractual liability, tort liability, negligence or other causes of liability, and whether or not such damages are foreseeable or unforeseeable. JCR Green Finance Framework Evaluation does not express any opinion on various risks (credit risk, price fluctuation risk, market liquidity risk, price fluctuation risk, etc.) related to green finance based on the green finance framework, which is the target of the evaluation. Furthermore, it is an expression of JCR's opinion at the present time and does not represent facts nor does it make any recommendation regarding risk assessment or decisions on the purchase, sale or holding of individual bonds, commercial paper, etc. JCR Green Finance Framework Evaluation may be modified, suspended or withdrawn due to changes in information, lack of information or other reasons. All rights pertaining to this document, including data from JCR Green Finance Framework Evaluation, are held by JCR. All or part of this document, including data from JCR Green Finance Framework Evaluation, is prohibited from being reproduced, modified or otherwise altered without the permission of JCR.

■Terminology

JCR Green Finance Framework Evaluation: This evaluates the extent to which the funds procured through Green Finance are appropriated for green projects as defined by JCR and the degree to which the management, operation and transparency of the Green Finance are ensured. Evaluations based on a 5-point scale are given from top to bottom using the Green 1(F), Green 2(F), Green 3(F), Green 4(F), and Green 5(F) symbols.

■Status of Registration as an External Evaluator of Sustainability Finance

- Registered as an External Reviewer of Green Bonds by the Ministry of the Environment
- ICMA (registered as an observer with the Institute of International Capital Markets)

■Status of registration as a credit rating agency, etc.

- Credit Rating Agency: the Commissioner of the Financial Services Agency (Rating) No.1
- EU Certified Credit Rating Agency
- NRSRO: JCR has registered with the following four of the five credit rating classes of the U.S. Securities and Exchange Commission's Nationally Recognized Statistical Rating Organization (NRSRO): (1) financial institutions, broker-dealers, (2) insurance companies, (3) general business corporations and (4) governments and municipalities. If the disclosure is subject to Section 17g-7 (a) of the Securities and Exchange Commission Rule, such disclosures are attached to the news releases appearing on the JCR website (<https://www.jcr.co.jp/en/>).

■For all other inquiries, please contact us below

TEL: 03-3544-7013 FAX: 03-3544-7026

Information Service Dept.

Japan Credit Rating Agency, Ltd.

Jiji Press Building, 5-15-8 Ginza, Chuo-ku, Tokyo 104-0061, Japan
Tel. +81 3 3544 7013, Fax. +81 3 3544 7026